



ALN 200 Series

Non _ Isolated



سیستم لولایی سری ۵۹

Hinged System 59 Series

صفحه Page	وزن محاسباتی Theoretical Weight	نوع پروفیل Profile Type	کد پروفیل Profile Code	نقشه پروفیل Drawing	ردیف No.
۴۷	1.240 kg/m	سپری پهن Wide Transom	ALN - 245		۷
۴۷	0.210 kg/m	زهوار دوجداره Glazing Bead	ALN - 213		۸
۴۷	0.270 kg/m	زهوار تک جداره Glazing Bead	ALN - 214		۹
۴۷	0.500 kg/m	پروفیل گردان فریم ۶۰ Angel Adapter	ALN - 225		۱۰
۴۸	0.650 kg/m	لوله محوری ۶۰ Pipe Instead Angel	ALN - 215		۱۱
۴۸	1.255 kg/m	پروفیل تحتانی درب Bottom Doors Profile	ALN - 235		۱۲

 Non-Isolated
 ALN 200
 Series

صفحه Page	وزن محاسباتی Theoretical Weight	نوع پروفیل Profile Type	کد پروفیل Profile Code	نقشه پروفیل Drawing	ردیف No.
۴۵	0.990 kg/m	فریم Frame	ALN - 208		۱
۴۵	1.170 kg/m	فریم عریض Wide Frame	ALN - 243		۲
۴۵	1.120 kg/m	لنگه داخل بازشو Internal Opening Vent	ALN - 209		۳
۴۶	1.055 kg/m	لنگه بیرون بازشو External Opening Vent	ALN - 223		۴
۴۶	0.700 kg/m	پروفیل میانی دو لنگه Inverter	ALN - 210		۵
۴۶	0.940 kg/m	سپری Transom	ALN - 211		۶

ALN - 223

Theoretical Weight : 1.055 kg/m

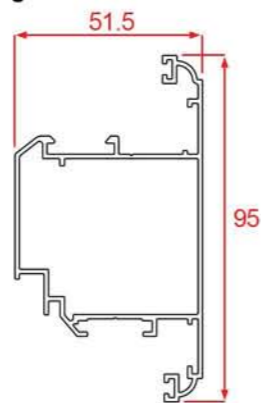

No. 4

ALN - 210

Theoretical Weight : 0.700 kg/m

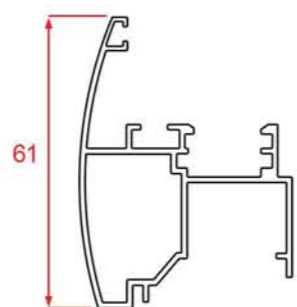

No. 5

ALN - 211

Theoretical Weight : 0.940 kg/m

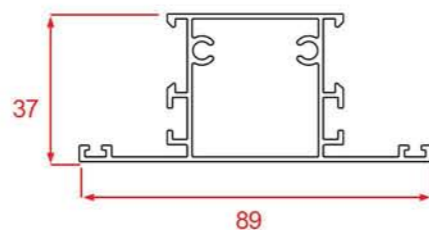

No. 6

ALN - 208

Theoretical Weight : 0.990 kg/m

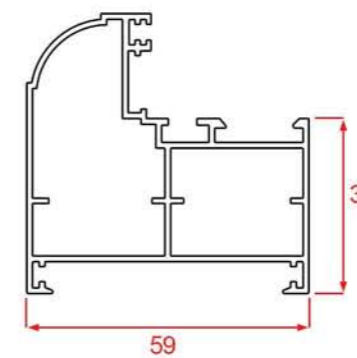

No. 1

ALN - 243

Theoretical Weight : 1.170 kg/m

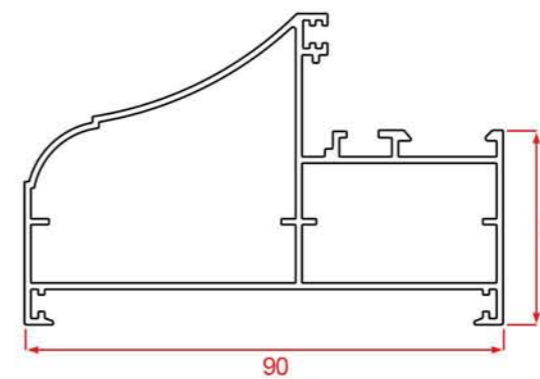

No. 2

ALN - 209

Theoretical Weight : 1.120 kg/m

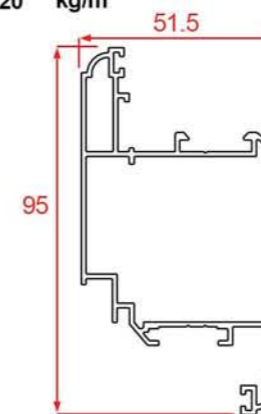

No. 3

ALN - 215

Theoretical Weight : 0.650 kg/m

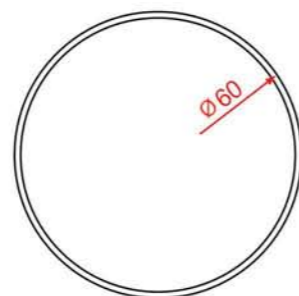

No. 11

ALN - 235

Theoretical Weight : 1.255 kg/m

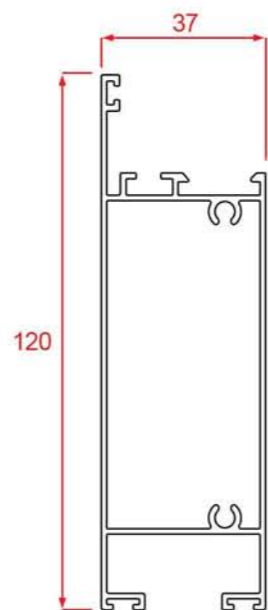

No. 12

Non-Isolated
ALN 200
Series

ALN - 245

Theoretical Weight : 1.240 kg/m

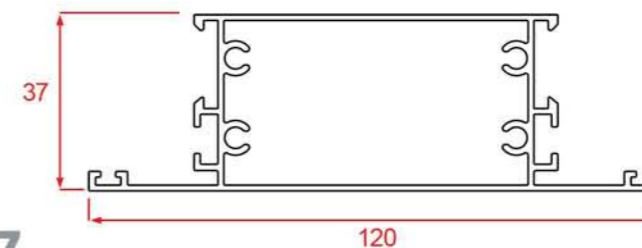

No. 7

ALN - 213

Theoretical Weight : 0.210 kg/m

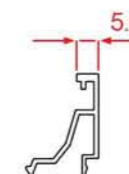

No. 8

ALN - 214

Theoretical Weight : 0.270 kg/m



No. 9

ALN - 225

Theoretical Weight : 0.500 kg/m

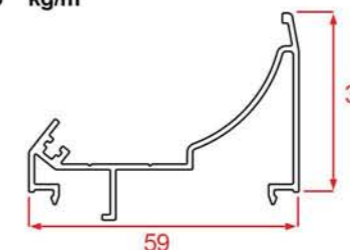

No. 10



Non-Isolated
ALN 200 Series

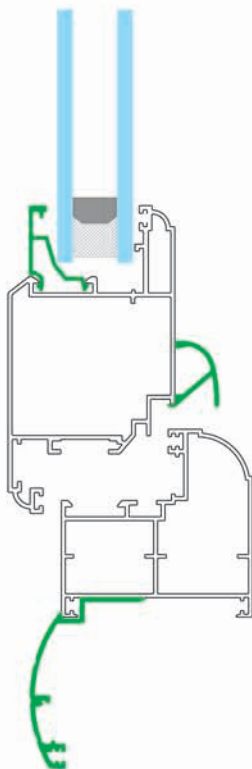
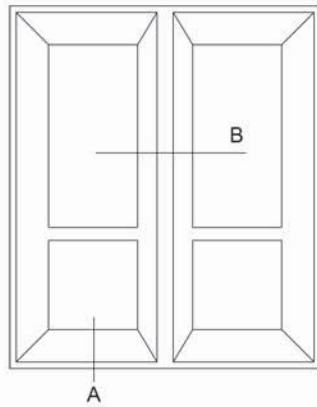

Section A

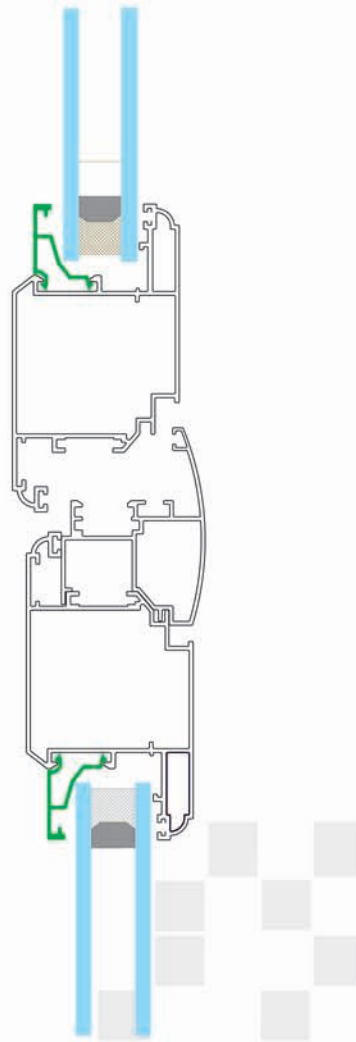

Section B